

QUICK-LOCK® T15-38

profile metalice utilizate la executia tavanelor suspendate demontabile cu structura vizibila sau retrasa, placi muchie A - E15

GRINZI SI PROFILE METALICE

STRUCTURI METALICE QUICK-LOCK® T15-38 PENTRU EXECUTIA TAVANELOR CASETATE CU STRUCTURA VIZIBILA SAU RETRASA - PLACI MUCHIE A / E15

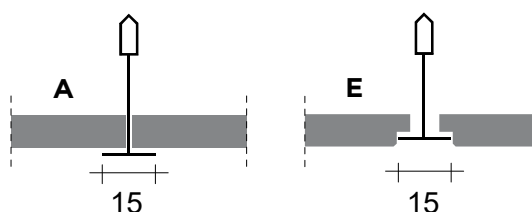

BENEFICII

Fabricate din otel galvanizat.
Conexiuni stabile, retea perfect rectangulara, planeitate
Instalare usoara si rapida

SISTEM

Quick-Lock® T15-38

executia tavanelor casetate cu structura vizibila (placi muchie A)
sau retrasa (placi muchie E15), module standard 600 x 600 / 600 x 1200 mm

Quick-Lock® T15-38

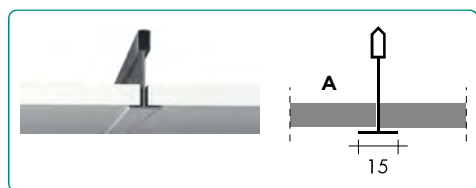

muchie A - structura vizibila

Quick-Lock® T15-38

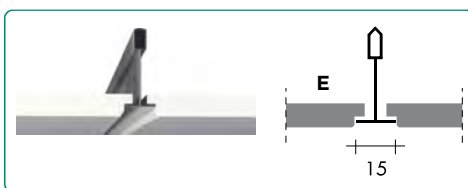

muchie E15 - structura retrasa



REACTIA LA FOC

Culori standard (snow-white / similar RAL 9003) - A1 conform EN 13501-1
Culori speciale aplicate ulterior - A2 conform EN 13501-1

ASPECT

Pentru produsele in culori standard - usor lucioase
Disponibile variantele ultramat - lipsa reflexiei luminii la unghiuri de incidenta mici

MARCAJE CE - EN 13964

DoP 0007-151E Quick-Lock 15

CALITATEA AERULUI LA INTERIOR

Sistemele Quick-Lock sunt clasificate A+

QUICK-LOCK® T15-38

GRINZI SI PROFILE
METALICE

SISTEM QUICK-LOCK T15-38
TAVAN SUSPENDAT DEMONTABIL CU STRUCTURA
VIZIBILA SAU RETRASA, PLACI MUCHIE A - E15



QUICK-LOCK® T15-38

Quick-Lock 15-38 profil principal

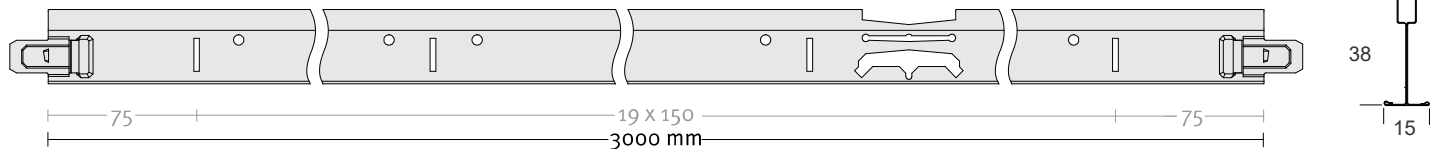

Quick-Lock 15-38 profil secundar

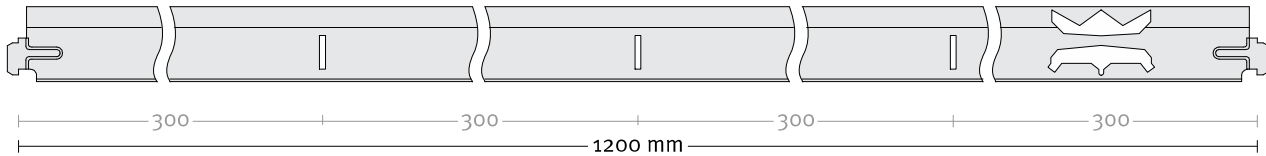

Quick-Lock 15-38 profil de compartimentare

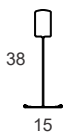
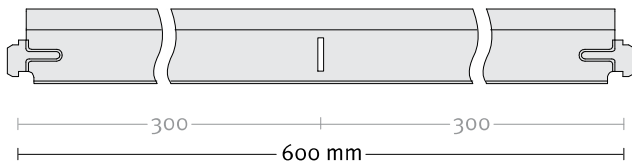

Profil principal QL 15-38, snow-white, slots c.t.c 150 mm
L=3000 mm, 20 buc/ctn, 60 ml/ctn, greutate 18,90 kg/ctn

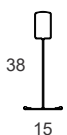

Profil secundar QL 15-38, snow-white, slots c.t.c 300 mm
L=1200 mm, 60 buc/ctn, 72 ml/ctn, greutate 22,70 kg/ctn

Profil de compartimentare QL 15-38, snow-white, slots c.t.c 300 mm
L=600 mm, 60 buc/ctn, 36 ml/ctn, greutate 11,40 kg/ctn



Profil perimetral QL 19-24, culoare alb snow-white
L=3000 mm, 30 buc/ctn, 90 ml/ctn, greutate 16,20 kg/ctn

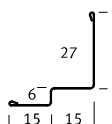

Profil perimetral QL W 27 x 6 x 15 x 15, culoare alb snow-white
L=3000 mm, 25 buc/ctn, 75 ml/ctn, greutate 22,20 kg/ctn

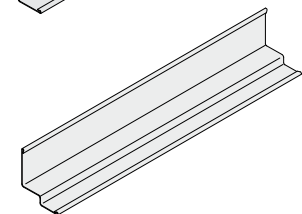
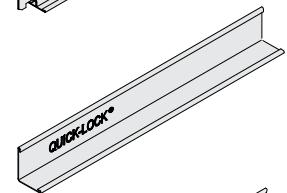
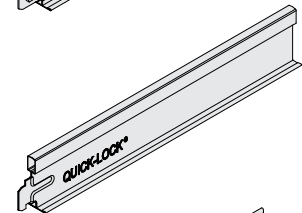
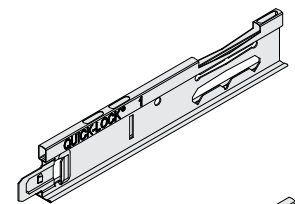

QUICK-LOCK® T15-38

GRINZI SI PROFILE
METALICE

SISTEM TAVAN SUSPENDAT DEMONTABIL COMPONENTE SI ALCATUIRE



Modul standard 600 x 600 mm

Quick-Lock T15-38

Modul standard 600 x 1200 mm

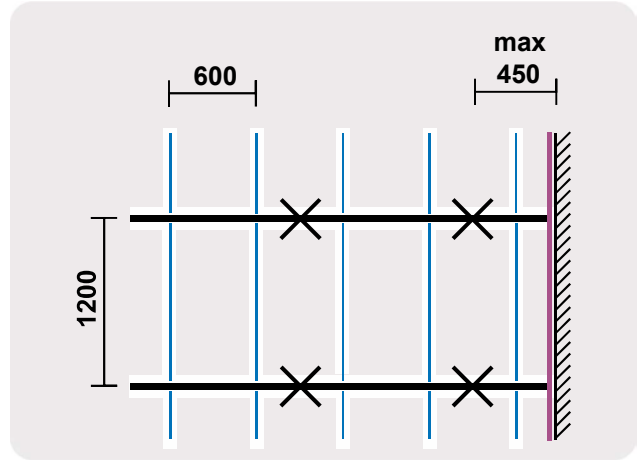
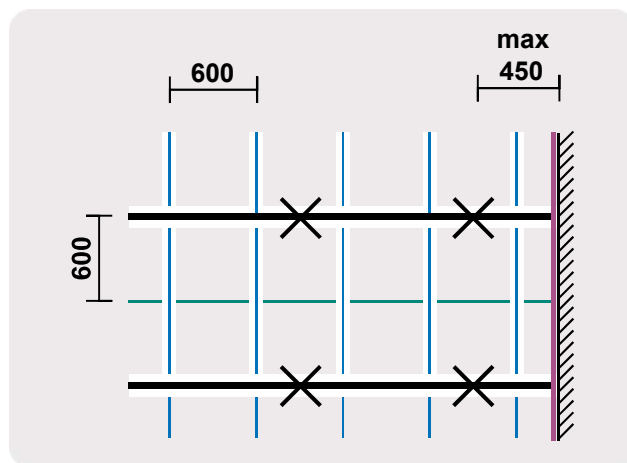

— Profil principal
QL 15-38 L3000 mm

— Profil secundar
QL 15-38 L1200 mm

— Profil compartimentare
QL 15-38 L600 mm

× Piese de suspendare
Sistem rapid
Sistem Nonius

— Profil perimetral
sectiune L / W
L3000 mm

PLACI MUCHIE A STRUCTURA QUICK-LOCK T15-38

PLACI MUCHIE E STRUCTURA QUICK-LOCK T15-38

CONEXIUNE PROFIL PRINCIPAL SISTEM RAPID DE SUSPENDARE

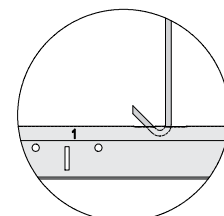
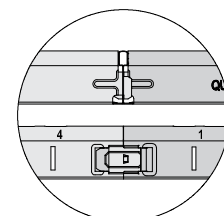

SISTEM QUICK-LOCK T15-38
STRUCTURA VIZIBILA, PLACI MUCHIE A

SISTEM QUICK-LOCK T15-38
STRUCTURA RETRASA, PLACI MUCHIE E

QUICK-LOCK® T15-38

GRINZI SI PROFILE METALICE

SISTEM TAVAN SUSPENDAT DEMONTABIL - MODUL TAVAN 600 x 600 mm montaj pe structura metalica Quick-Lock T15-38

- 1 modul 600 x 600 mm, placa muchie A / E15
- 2 profil principal Quick-Lock T15-38
- 3 profil secundar Quick-Lock T15-38
- 4 profil compartimentare Quick-Lock T15-38
- 5 profil perimetral Quick-Lock sectiune L / W *
- 6 elemente de suspendare (sistem rapid)
- 7 optional, saltea din vata minerala

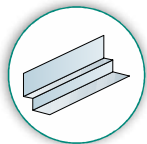
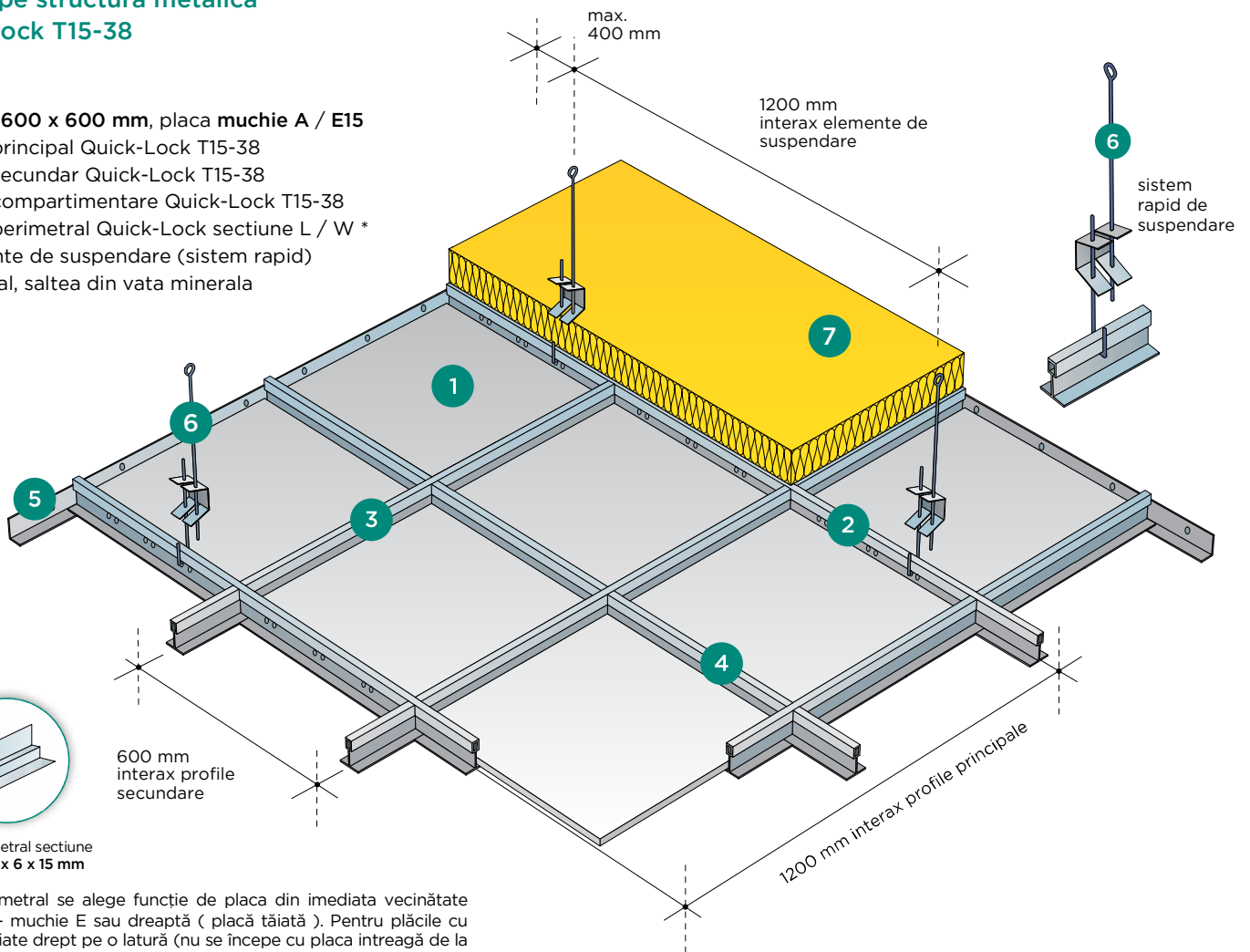

profil perimetral sectiune
W 27 x 15 x 6 x 15 mm

* Profilul perimetral se alege functie de placa din imediata vecinatate a peretelui - muchie E sau dreapta (placă tăiată). Pentru plăcile cu muchie E tăiate drept pe o latură (nu se începe cu placa întreagă de la perete) se folosește profilul W

sectiune W 27 x 15 x 6 x 15 mm

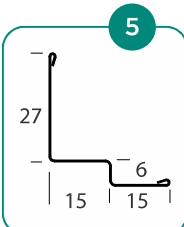
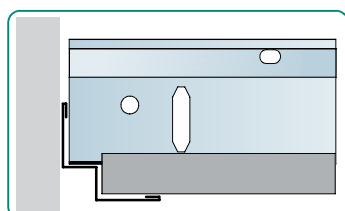

profil perimetral sectiune L 19 x 24 mm

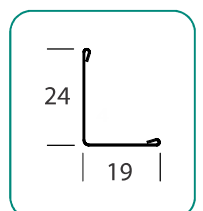
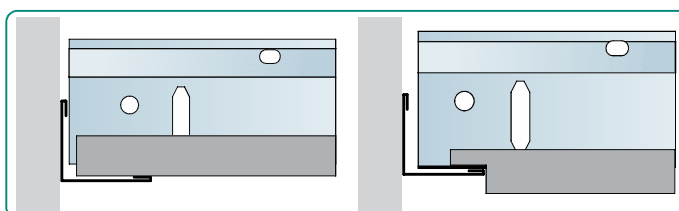

QUICK-LOCK® T15-38

GRINZI SI PROFILE METALICE

SISTEM TAVAN SUSPENDAT DEMONTABIL - MODUL TAVAN 600 x 1200 mm montaj pe structura metalica Quick-Lock T15-38

- 1 modul 600 x 1200 mm, placa muchie A
- 2 profil principal Quick-Lock T15-38
- 3 profil secundar Quick-Lock T15-38
- 4 profilul de compartimentare nu este necesar in configuratia standard
- 5 profil perimetral Quick-Lock sectiune L 19 x 24
- 6 elemente de suspendare (sistem rapid)
- 7 optional, saltea din vata minerala

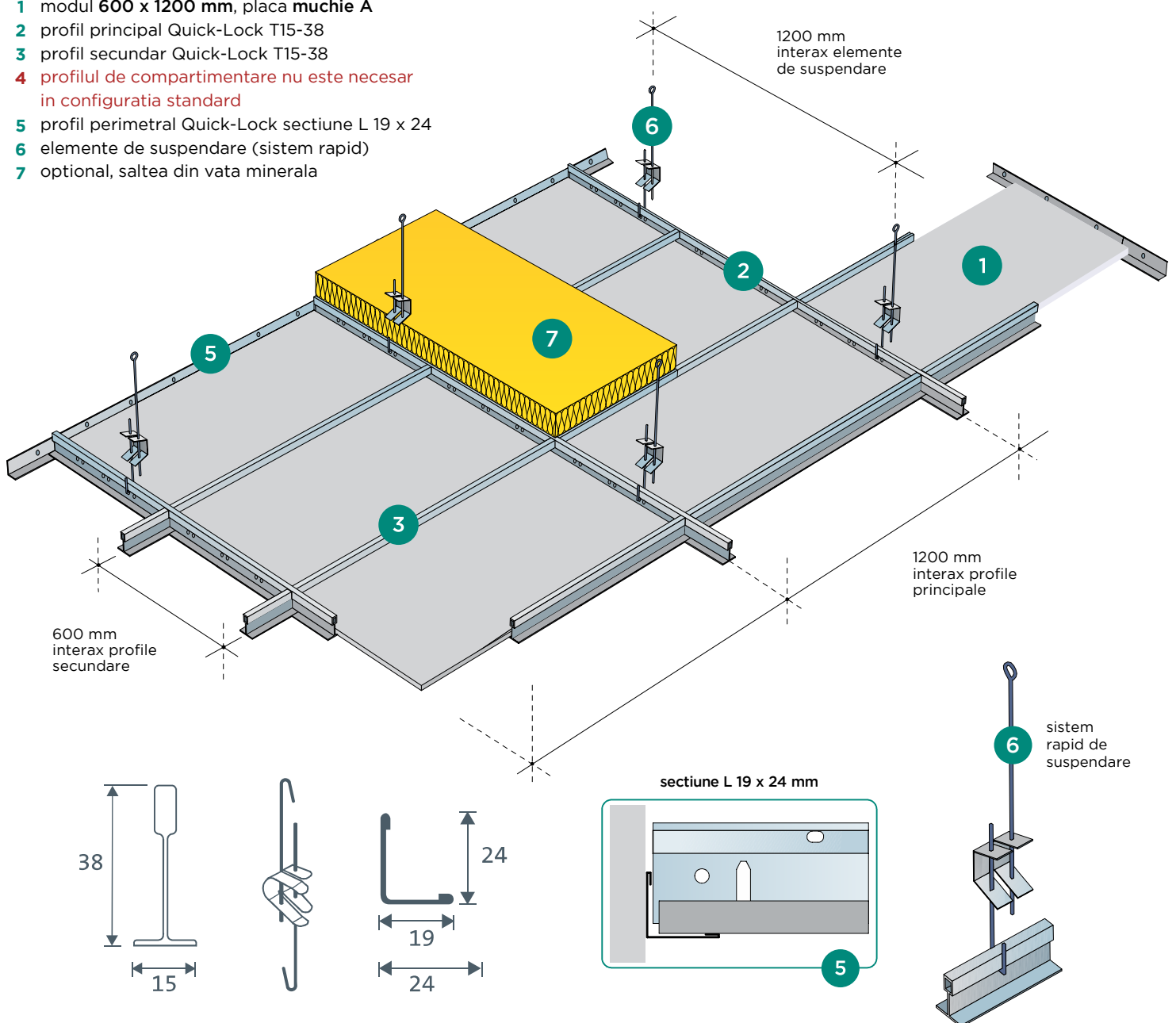

QUICK-LOCK® T15-38

GRINZI SI PROFILE METALICE

SISTEM QUICK-LOCK T15-38 TAVAN SUSPENDAT DEMONTABIL CU STRUCTURA VIZIBILA SAU RETRASA, PLACI MUCHIE A - E15

Modul standard 600 x 600 mm

Quick-Lock T15-38

Modul standard 600 x 1200 mm

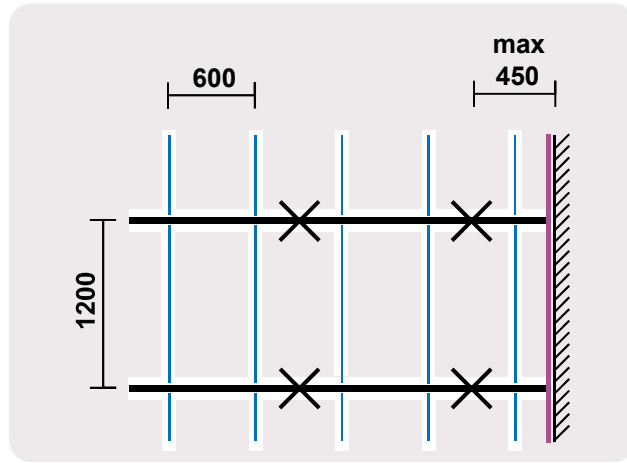
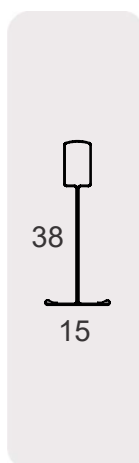
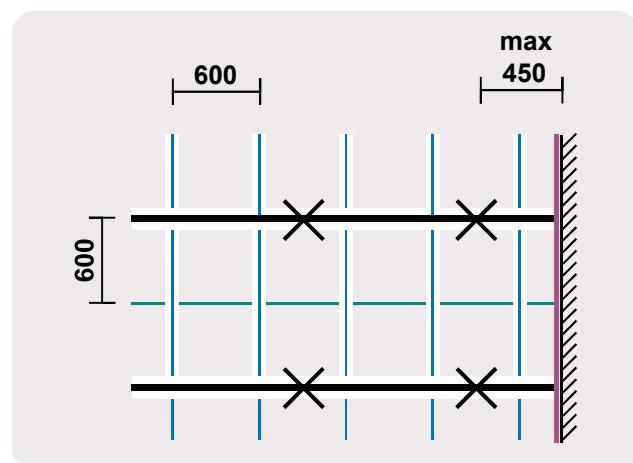
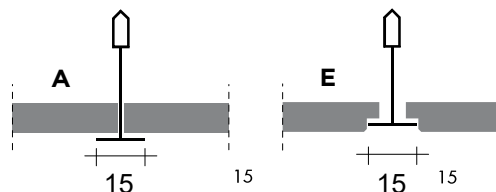

— Profil principal
QL 15-38 L3000 mm

— Profil secundar
QL 15-38 L1200 mm

— Profil compartimentare
QL 15-38 L600 mm

× Piese de suspendare
Sistem rapid
Sistem Nonius

— Profil perimetral
secțiune L / W
L3000 mm

NECESAR ESTIMAT DE MATERIALE PENTRU EXECUTIA UNUI m² DE TAVAN CASETAT MODUL 600 x 600 mm

MODUL 600 x 600 mm
Placă muchie A sau E 2,8 plăci / m²

PROFILE

Profil principal QL 15-38 L3600 mm	0,90 m
Profil secundar QL 15-38 L1200 mm	1,35 m
Profil de compartimentare QL 15-38 L600 mm	0,96 m
Profil de perimetral QL secțiune L / W	0,70 m

ACCESORII - SISTEM RAPID

Tijă cu inel	0,81 buc
Tijă cu cârlig	0,81 buc
Prelungitor tijă	0,81 buc
Diblu DN6	0,81 buc
Șurub cu diblu 6x45mm	1,52 buc

NECESAR ESTIMAT DE MATERIALE PENTRU EXECUTIA UNUI m² DE TAVAN CASETAT MODUL 600 x 1200 mm

MODUL 600 x 1200 mm
Placă muchie A 1,4 plăci / m²

PROFILE

Profil principal QL 15-38 L3600 mm	0,90 m
Profil secundar QL 15-38 L1200 mm	1,35 m
Profil de compartimentare QL 15-38 L600 mm	---
Profil de perimetral secțiune L 19 x 24 mm	0,70 m

ACCESORII - SISTEM RAPID

Tijă cu inel	0,81 buc
Tijă cu cârlig	0,81 buc
Prelungitor tijă	0,81 buc
Diblu DN6	0,81 buc
Șurub cu diblu 6x45mm	1,52 buc

IMPORTANT ! Necesarul de materiale reprezintă o estimare cu caracter informativ, bazată pe un calcul ce ia în considerare, de cele mai multe ori, o suprafață rectangulară. Este **obligatorie** verificarea cantităților estimate în raport cu situația reală, cu cerințele documentației specifice sau cu cerințele caietelor de sarcini. Nu sunt luate în considerare pierderile de material (5 + 10%). Cantitățile necesare reale depind de geometria și dispunerea suprafețelor

Profilul perimetral se alege funcție de placa din imediata vecinătate a peretelui - muchie E sau dreaptă (placă tăiată). Pentru plăcile cu muchie E tăiate drept pe o latură (nu se începe cu placa întreagă de la perete) se folosește profilul W

QUICK-LOCK® T15-38

GRINZI SI PROFILE METALICE

SISTEME QUICK-LOCK T15-38 TAVAN SUSPENDAT DEMONTABIL CU STRUCTURA VIZIBILA SAU RETRASA, PLACI MUCHIE A - E15

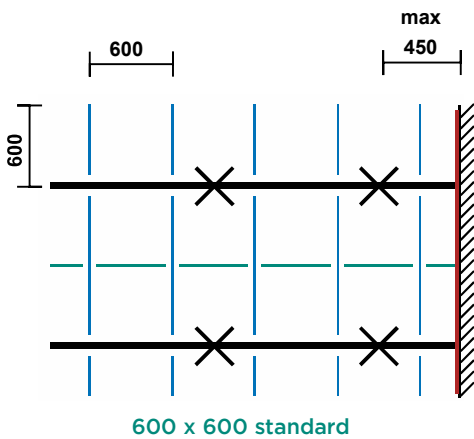

- Profil principal QL T24-38 —
- Profile compartimentare QL T24-32 —
- Profile secundar QL T24-32 —
- Piese de suspendare - sistem rapid X
- Profil de compartimentare sectiune L sau W —

Inaltime minima plenum - inaltime minima de montaj placa muchie A / E 100 mm

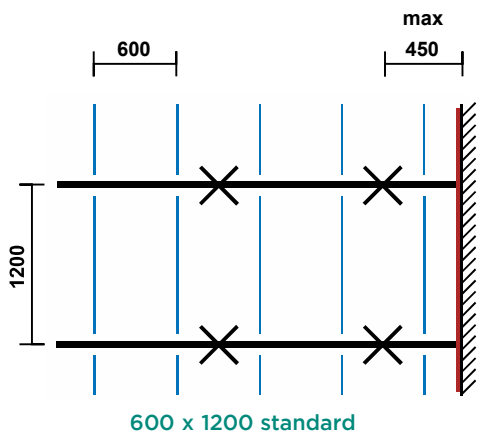

INCARCARI ADMISIBILE SISTEM QUICK-LOCK T 15-38



Diagrama indica incarcările permise ale sistemului și planitatea tavanului funcție de dimensiunile plăcii și de distanța între piesele de suspendare. Informațiile prezentate sunt conforme cu lucrări uzuale executate în spații interioare. Nu au fost luate în calcul alte tipuri de încărcări. Primul punct de suspendare nu trebuie situat la o distanță mai mare de 450 mm față de marginea tavanului. Conexiunile profilelor principale se execută la o distanță de maxim 300 mm de cel mai apropiat punct de suspendare.

- Deformare sistem - 1 mm
- Deformare sistem - 2 mm
- Limita domeniului (M_{adm} clasa 1 c.f. EN 13964)
- incarcare / punct de suspendare pana la 15 kg pt. sistem rapid
- incarcare / punct de suspendare pana la 25 kg pt. sistem Nonius

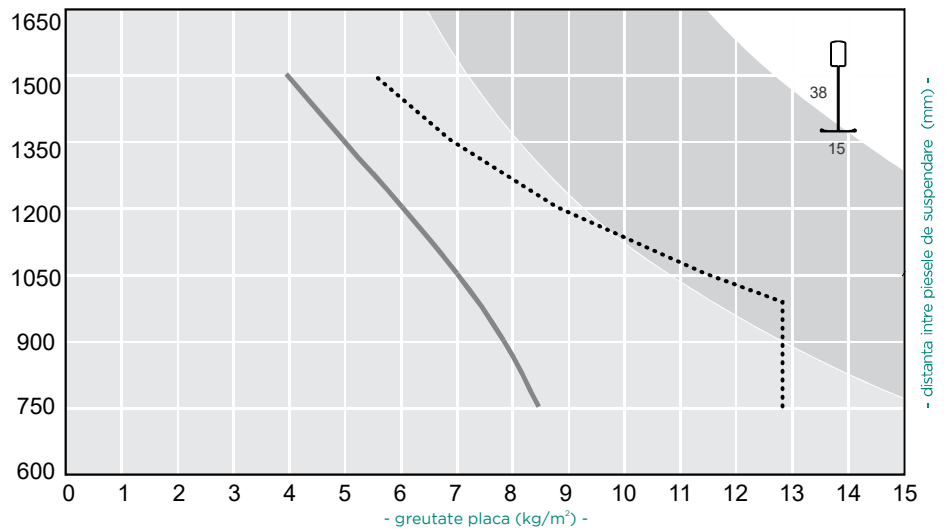
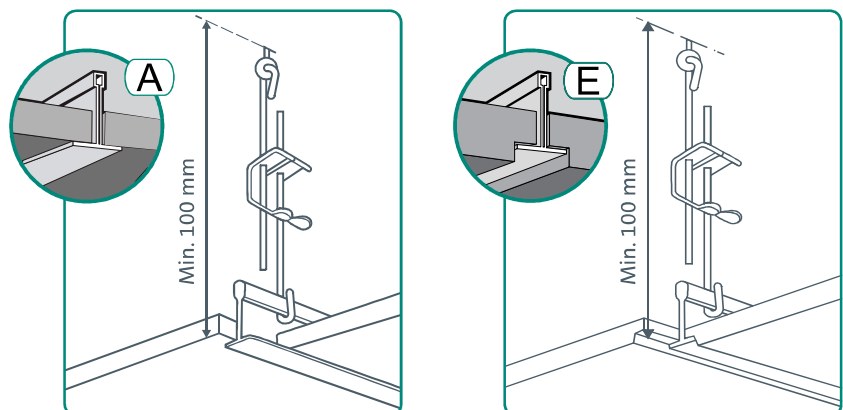

QUICK-LOCK® T15-38

GRINZI SI PROFILE
METALICE

PORTOFOLIU PLACI DIN GIPS-CARTON MUCHE A / E
MONTAJ PE STRUCTURA QUICK-LOCK T15-38



Gyptone® Tiles

Placi din gips-carton cu sau fara proprietati acustice

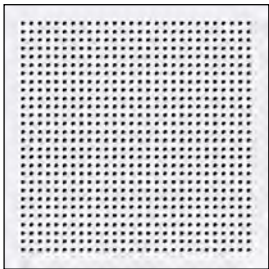

Sixto 60

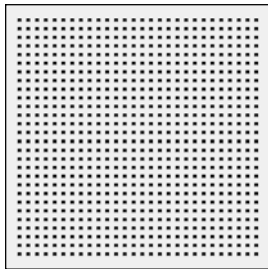

Quattro 20

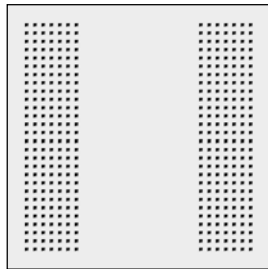

Quattro 22

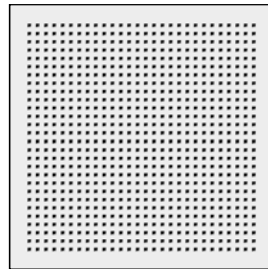

Quattro 50

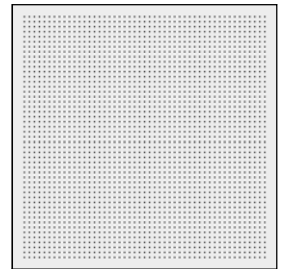

Quattro 70

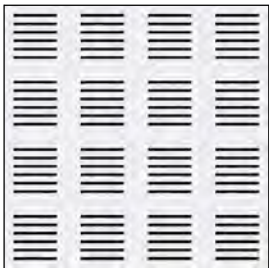

Line 4

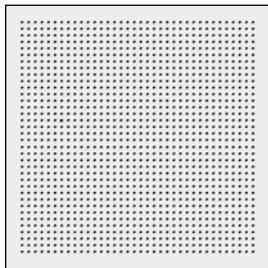

Point 11

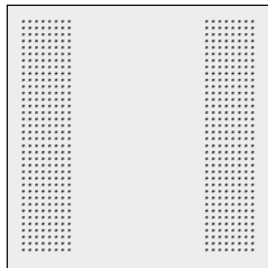

Point 12

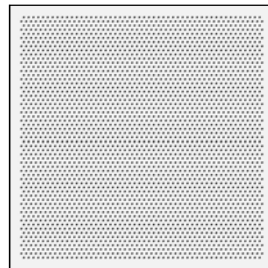

Point 80

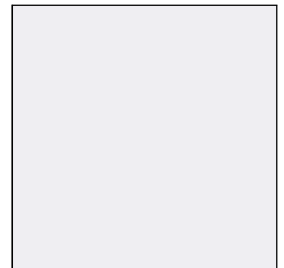

Base 38
Base 31

Casoprano®

Placi din gips-carton fara proprietati acustice



Casostar



Casoroc



Casobianca



SAINT-GOBAIN ROMANIA · RIGIPS

Sos. Pipera nr. 43
Floreasca Pak · Corp A · etaj 3
Sector 2 · Bucuresti · Romania
Tel: +40 (21) 207 57 50/51
office.rigips@saint-gobain.com

www.rigips.ro

Informatiile din acest document au un caracter informativ si reprezinta doar o descriere a produselor. Nu se refera la o aplicatie specifica, particulara. Functie de dezvoltarea produselor noastre ne rezervam dreptul de a modificaparametrii fara un anunt in prealabil. Datele prezentate nu pot constitui baza unor reclamatii, oricare ar fi natura acestora. Va recomandam sa consultati Departamentul Tehnic Rigips.

Links

Sisteme Quick - Lock
DoP 0007-151E | DoP 0007-180E
www.rigips.ro